

SHIPE®



FOCUS ON THE PRODUCTION AND SERVICE OF HIGH-END MARINE PRODUCT

专注于高端船舶产品的生产与服务

芜湖市协普机器有限公司
WUHU SHIPE MACHINE CO.,LTD.

地址: 中国(安徽)自由贸易试验区芜湖片区永昌路10号 P.C: 241000

Add: No.10 Yongchang Road, Wuhu District, Pilot Free Trade Zone (Anhui) China

Tel: 86-553-5223351

Web: www.shipe126.com

Fax: 86-553-5222566

E-mail: admin@shipe126.com

芜湖市协普机器有限公司

WUHU SHIPE MACHINE CO.,LTD



品牌手册目录

BRAND MANUAL

01/02

品牌介绍

BRAND INTRODUCTION

03/04

公司设备

COMPANY FACILITY

05/06

公司荣誉

COMPANY HONOR

07/08

合作项目

COOPERATION PROJECT

09/11

主要产品

MAIN PRODUCTS

12/24

邮轮配套

CRUISE PRODUCT

25/34

电气设备及附件

ELECTRIC EQUIPMENT
AND ACCESSORIES

35/40

自动打磨机

AUTOMATIC GRINDING
MACHINE

41/45

定制化产品

CUSTOMIZED PRODUCT



品牌介绍

BRAND INTRODUCTION



芜湖市协普机器有限公司专注于高端船舶产品的生产与服务，公司成立于1999年，建筑面积近2万平方米，经过二十余载的执着追求和创新，正不断跨步迈向品牌的新征程！

公司始终坚持精品战略，我们先后添置了一大批先进的专业加工设备，还添置了一批先进的专业检测设备。目前已发展成设备精良、管理规范、产品丰富的省级优秀企业。我们还计划进一步引进一批自动化生产设备和检测设备，最终实现智能化生产！

WUHU SHIPE MACHINE CO., LTD, focuses on the production and service of high-end ship products. SHIPE was incorporated in 1999, which has building area nearly 20,000 square meters, after over 20 years persistent pursuit and innovative development, SHIPE is now striding forward to the new journey.

SHIPE always insists the super-quality strategy, we have acquired a large number of advanced professional processing equipment, a number of advanced testing equipment has been applied as well. Now has developed into a provincial excellent enterprise with well-equipped, standardized management and various products. We're planning to introduce a number of automatic production and testing equipment step by step, and to finally realize the intelligent production.

公司主营四大类规模化产品：邮轮配套、电气设备及附件、自动打磨机以及为客户提供全方位定制化产品解决方案。二十多年行业经验，30项产品专利资质，产品远销15个海内外国家及地区。

SHIPE has mainly products in four categories: Cruise Products, Electrical Equipment and accessories, Automatic Grinding Machine and also to provide customers a full range of Customized Products solution. Over 20 years industry experiences, 30 product patent qualifications, sold into 15 countries and regions worldwide.

其中折叠床系列、船用镜柜、镜前灯、筒灯等系列产品，已成为国内外主流客户的首选，并广泛应用于豪华邮轮市场，相继为地中海邮轮、皇家加勒比邮轮、中华复兴号K36、维京邮轮NB488、极地邮轮、TT-LINE、STENA LINE等豪华邮轮、客滚船提供一体化内装配套产品服务。

Our products such as Pullman Bed series, Mirror Cabinets, Mirror Lights, etc., has become the first choice for main customers globally, and already widely used in luxury cruise market. We have successively provided integrated interior ancillary products and services for luxury cruises and ro-ro passenger ships such as MSC, RCL, ZHONGHUA FUXING K36, VIKING Line NB488, POLAR CRUISE, TT Line, STENA Line and so on.

诚信是企业发展的根基，在生产经营的各个环节，我们始终铭记企业的责任和信誉，坚持系统化、现代化的管理模式，是芜湖市A级纳税信用单位。公司先后通过了国军标质量体系认证、CCS质量体系认证、安全生产标准化认证、A类装备承制单位资格认证。

协普，始终坚持以客户为中心，快速响应客户需求，持续为客户创造价值的营销理念。

全体协普人已扬帆起航，展望未来！我们将秉持技术创新的发展理念，坚持精益求精的工匠精神，致力于为高端客户提供优质产品和服务。

Integrity is the foundation of company development. In all aspects of production and management, we always remember the responsibility and reputation of SHIPE. We insist on the systematic and modernization of management models and we get a class A tax credit in Wuhu City. We have successively passed the GJB Quality System Certification, CCS Quality Management System Certification, Safety Production Standardization Certification, and got the Class A qualification for manufacturing military products.

SHIPE has always focus on customer-centric, quickly responds to customer needs, keep continuously create values for customers as the marketing concept.

All of the SHIPE people have set sail and look forward to the future. We will uphold the development concept of technical innovation, strive for excellence craftsman spirit, and devoted to provide quality products and services for high-end customers.

公司设备

COMPANY FACILITY

为实现精品战略,我们先后添置了一大批先进的专业加工设备,如:通快的数控冲床、激光切割机、机器人激光焊接自动化单元、双机联动6轴数控折弯机、双机联动焊接机器人、数控加工中心、自动化喷涂生产线、自动打磨机等。

还添置了一批先进的专业检测设备,如:综合试验台、盐雾试验箱、振动试验台、摇摆试验台、防水试验箱、灯具光电性能测试仪、金属分析仪等。

我们还计划逐步引进一批自动化生产设备和检测设备,最终实现智能化生产。

We have acquired a large number of advanced professional processing equipment. Such as TRUMPF's CNC punch, CNC laser cutting machine, laser welding automation unit, 6 axis CNC bending machine, welding robot, CNC machining centre, automatic spraying production line Automatic grinding machine and so on.

We have also acquired a number of advanced professional testing equipment. Such as salt spray test machine, vibration table, swing test platform, waterproof grade test box, lamps and lanterns optical performance test instruments, metal analyzer etc.

We plan to introduce a number of automated production equipment and testing equipment step by step and to realize intelligent production in the end.

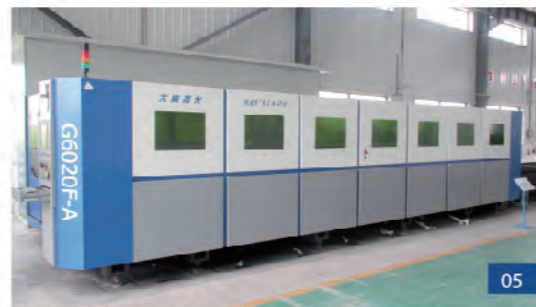

- 01 自动打磨机 Automatic Grinding Machine
- 02 焊接机器人臂 Welding Robot
- 03 通快数控冲床 Trumf's Cnc Punch
- 04 数控转塔冲床 Cnc Turret Punch Press
- 05 2x6米激光切割机 Cnc Laser Cutting Machine
- 06 6米双机联动数控折弯机 6 Axis Cnc Bending Machine
- 07 数控折弯机 Cnc Bending Machine
- 08 机器人激光焊接自动化单元 Laser Welding Automation Unit

- 09 自动化喷涂生产线 Automatic Spraying Production Line
- 10 综合试验平台 Integrated Test Platform
- 11 盐雾试验箱 Salt Spray Test Machine
- 12 淋雨试验箱 Waterproof Grade Test Box
- 13 振动试验台 Vibration Table
- 14 金属分析仪 Metal Analyzer
- 15 积分球 Integrating Sphere
- 16 灯具光电性能测试仪 Lamps And Lanterns Optical Performance Test Instruments

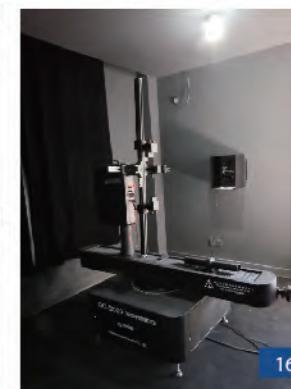
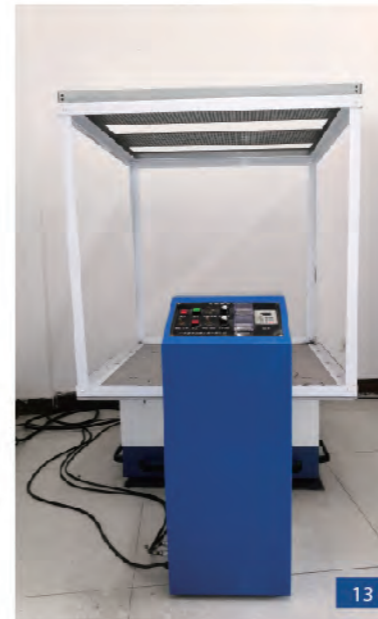
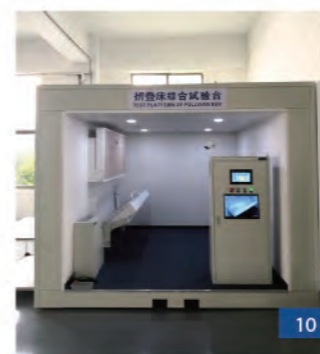
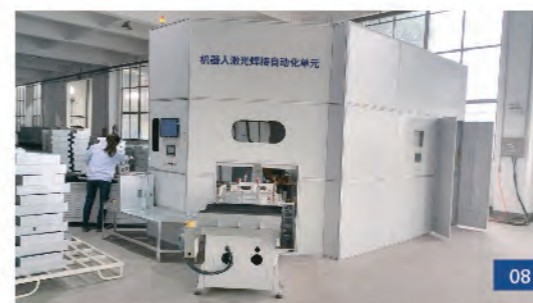

公司荣誉

COMPANY HONOR

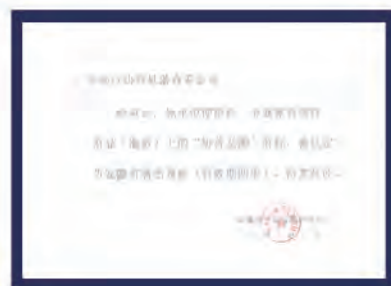

1



2



3



4



5



6



12



11



10



9



8

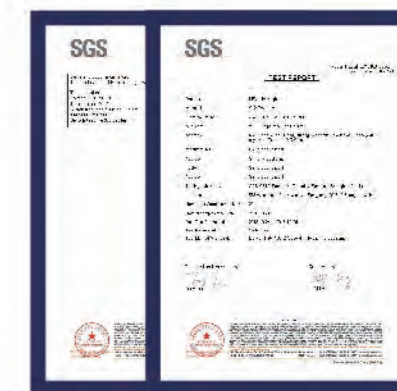

7

- 1. 著名商标
- 2. A级纳税信用等级
- 3. 高新技术企业证书
- 4. 发明专利证书
- 5. 实用新型证书
- 6. 外观专利证书
- 7. SGS证书
- 8. CE证书
- 9. 高新技术产品认定书
- 10. CCS产品证书
- 11. 防护等级证书
- 12. 质量管理体系证书

- 1. Famous Trademark
- 2. Grand A Credit Rating Certificate
- 3. High and New Technology Enterprise Certificate
- 4. Invention Patent Certificate
- 5. Utility Model Patent Certificate
- 6. Design Patent Certificate
- 7. SGS Certificate
- 8. CE Certificate
- 9. High-tech Product Certificate
- 10. CCS Product Certificate
- 11. Protection Class Certificate
- 12. Quality Management System Certificate

合作项目
COOPERATION PROJECTS

主要合作项目

MAIN COOPERATION PROJECTS

地中海邮轮 MSC CRUISE	豪华邮轮镜柜 CRUISE MIRROR CABINET	2015~至今 TILL NOW
皇家加勒比邮轮 RCL CRUISE	豪华邮轮镜柜 CRUISE MIRROR CABINET	2017~至今 TILL NOW
中华复兴号 K36 项目 ZHONGHUA FUXING SHIP K36	折叠床 PULLMAN BED	2018~2019
维京游轮 NB488 项目 VIKING LINE NB488	折叠床 PULLMAN BED	2019~至今 TILL NOW
极地邮轮 POLAR CRUISE	钢质床 STEEL BED	2019~至今 TILL NOW
TT LINE	折叠床 PULLMAN BED	2020~至今 TILL NOW
STENA LINE	折叠床 PULLMAN BED	2020~至今 TILL NOW



主要产品

MAIN PRODUCTS

公司自成立以来，产品远销海内外市场，包括豪华邮轮市场、船舶内装行业及军方市场。产品主要包括：邮轮配套、电气设备、自动打磨机及定制化产品。

邮轮配套

舱室家具及五金

床系列：该系列产品包括 铝合金折叠床*、沙发床*、吸顶式折叠床*、钢质双层床、钢质单层床、钢丝床等。

镜柜、浴柜系列：该系列产品包括豪华邮轮镜柜*、舰用镜柜、镜柜、浴柜及化妆镜等。

卫浴五金系列：该系列产品包括毛巾架、化妆品托架、防浪扶手、手纸盒、杯架、衣帽钩、马桶刷、抽风头、地漏、废纸篓、水箱等。

电气设备及配件

- 电控柜系列
- 配电箱系列
- 电加热器系列
- 船载岸电系统：该系列产品包括岸电箱、测量箱、联调试验箱、电缆绞车等。
- 船用灯具系列：该系列产品包括镜前灯、筒灯、走道灯、LED 舱顶灯等。
- 电气附件：该系列产品包括：快速接头、接线盒及接线箱等。

自动打磨机

目前主要是龙门式 5 轴自动打磨机，后期规划开发打磨机器人、自动打磨流水线、智能打磨机等。

定制化产品

公司依托产业发展布局，力争为高端客户提供全方位定制化产品，如：消音器、舱盖、变矩邮箱、进气节气门、排气管盖、排气管盖、车体、手机存放柜、物品柜等。

Our products have sold at home and abroad since establishment, including fields of cruise market, marine accommodation and military market. Our main products include: cruise product, electrical equipment, automatic grinding machine and customized product.

CRUISE PRODUCT

Cabin furniture and hardwares

Bed series include pullman bed*, sofa bed*, ceiling pullman bed*, steel bunkbed, steel single bed and spring bed, etc..

Mirror cabinet series include cruise mirror cabinet*, naval mirror cabinet, mirror cabinet, bathroom cabinet and cosmetic mirror, etc..

Bathroom hardware series include towel bar, cosmetic shelf, bathroom handrail, tissue box & holder, tooth cup holder, coat hook, toilet brush, exhaust valve, bathroom drain, trash can, water tank, etc.

ELECTRIC EQUIPMENT AND ACCESSORIES

- Electric control cabinet series
- Distribution box series
- Electric heater series
- Shipboard shore power system series include shore electric box, surveying, joint adjustment test box, cable winch, etc.
- Marine light series include mirror light, down light, led cabin ceiling light, etc.
- Electrical accessories include quick connector, junction box, etc.

AUTOMATIC GRINDING MACHINE

At present, it is mainly gantry type 5-axis automatic grinding machine, and later planning and development of grinding robot, automatic grinding line, intelligent grinding machine, etc.

CUSTOMIZED PRODUCT

Shipe relies on the industrial development layout, and strive to provide high-end customers with a full range of customized products, such as: muffler, hatch cover, change torch mailbox, intake valve, exhaust pipe cover, exhaust pipe cover, car body, mobile phone storage cabinet, personal items cabinet, etc.

邮轮配套
CRUISE PRODUCT

邮轮配套

CRUISE PRODUCT



品牌是企业发展的灵魂,协普折叠床系列作为邮轮舱室家具优势产品,是公司自主研发的专利产品,主要用于豪华邮轮、客滚船。充分利用和节省了船舶起居空间,安全、便捷、美观。产品一经推出,迅速占领豪华邮轮市场。

邮轮镜柜、浴柜作为舱室卫浴的明星产品,针对豪华邮轮舒适、奢华的特点设计制造,受到国内外客户高度认可并被广泛应用于高端船舶市场。

作为配套卫生单元产品,公司拥有全系列卫浴五金可供不同客户内装需求。

Brand is the soul of company development, as the superior product of cruise cabin furniture, SHIPE Pullman bed series are patent products independently developed by our company, which are mainly used in luxury cruises and ro-ro passenger ships. They make full use of cabin space, with safe, convenient and decorative function. These products quickly occupied the luxury cruise market once launched.

Cruise Mirror Cabinet and Bathroom Cabinet act as the star products in cabin bathroom unit, which focus on design style, accessories selection and appearance of cabinet according to the characteristics of comfort and luxury of cruise. Personalized design and keep on improving make our products widely recognized by our clients, they have already widely apply in high end ship market.

As accessory products of bathroom unit, SHIPE has full range of bathroom hardware to satisfy different customer demands.

折叠床系列

PULLMAN BED SERIES

该系列产品包括铝合金折叠床、沙发床、吸顶式折叠床、钢质双层床、钢质单层床、钢丝床等。

铝合金折叠床、沙发床、吸顶式折叠床主要用于豪华邮轮、客滚船。

折叠床安装在起居舱室舱壁上，可以折叠；

沙发床折叠后可以替代沙发使用，开启可以当床使用；

吸顶式折叠床可以收进天花板，开启与闭合具有助力缓冲功能充分利用和节省了船舶起居空间，安全、方便、美观。

每个系列产品都能满足静载荷、动载荷及疲劳试验等内控标准，使用寿命可达20年以上，因产品品质高端、价格合理，产品一经推出，迅速占领国内市外市场，在多个豪华邮轮项目上投入使用，成为国内最大的船用折叠床的供应商。

A型 铝合金折叠床

* 明星产品 Star Product

A TYPE ALUMINUM PULLMAN BED

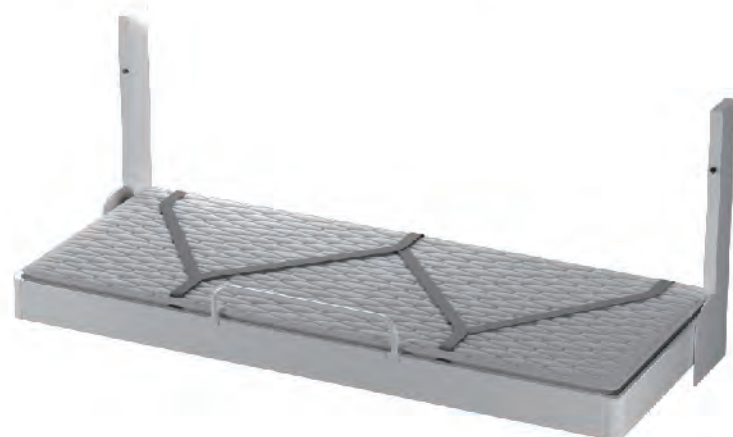

C型 铝合金折叠床

* 明星产品 Star Product

C TYPE ALUMINUM PULLMAN BED



Bed series include pullman bed, sofa bed, ceiling pullman bed, steel bunkbed, steel single bed and spring bed.

They are mainly used for luxury cruise ships and ro-ro passenger ship.

Pullman bed is installed on bulkhead of cabin, it can be fold up and down.

Sofa bed can be used as sofa when fold up and as bed when down.

Ceiling bed can be colsed into ceiling. they make full usage of space in cabin and with safe, convenient and decorative feature.

Each series of products can meet the internal control standard of static load, dynamic load and fatigue test in our company standard and service life can reach more than 20 years. those kinds of products quickly occupy the domestic market once launched because of the high quality and reasonable price.

A型 沙发床

* 明星产品 Star Product

A TYPE SOFA BED



C型 沙发床

* 明星产品 Star Product

C TYPE SOFA BED



吸顶式折叠床 CEILING PULLMAN BED



吸顶式折叠床 CEILING PULLMAN BED

* 明星产品 Star Product

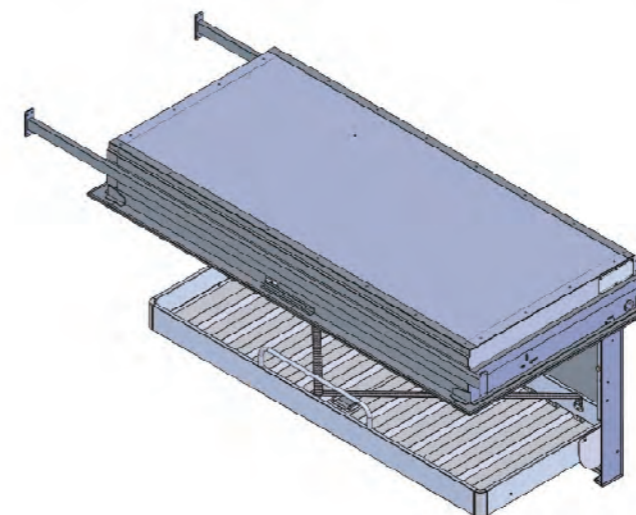

主要参数表 Main specification						
序号 No.	尺寸代号 Dimension code	标准尺寸 Standard dimension (mm)	床垫推荐 Recommended mattress size 尺寸 (mm)	最大外形尺寸 Max dimension (mm)	客户要求 Customer dimension 尺寸(mm)	备注 Remark
1	L	2000	L-10-L-20	L+337		
2	W	800	W-10-W-20	W+208		

可根据客户对天花板床尺寸进行调整。调整以天花板床床框内尺寸为基准调整。
Dimension of pullman bed can be adjusted according to customer's requirement and it should be based on the inner dimension of bed frame.

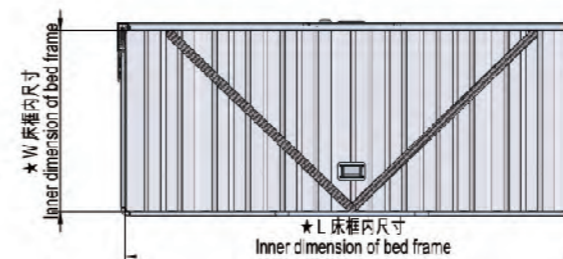
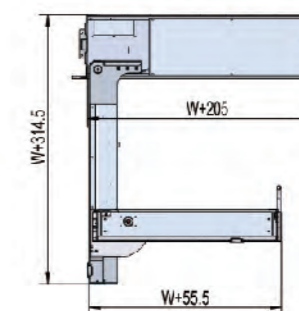
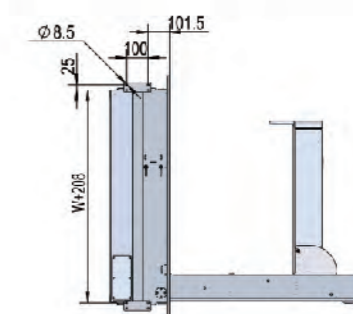
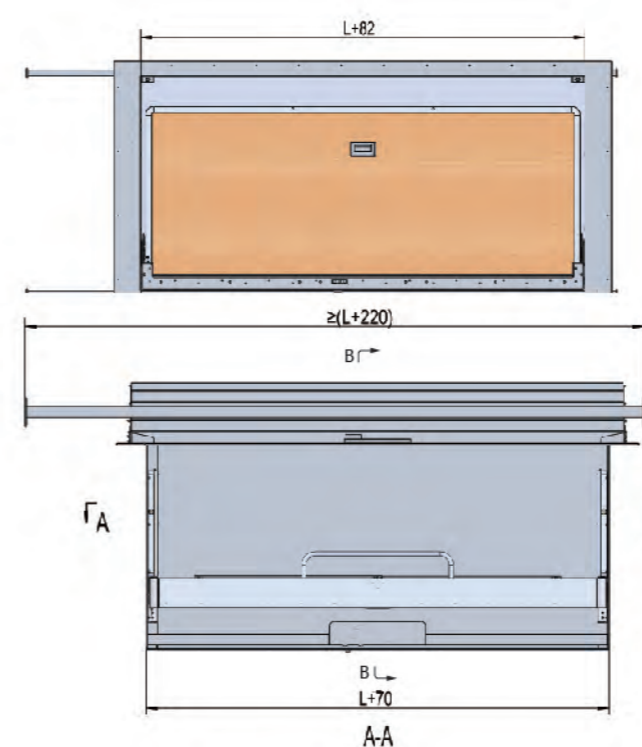

综合试验 COMPRHENSIVE EXPERIMENT

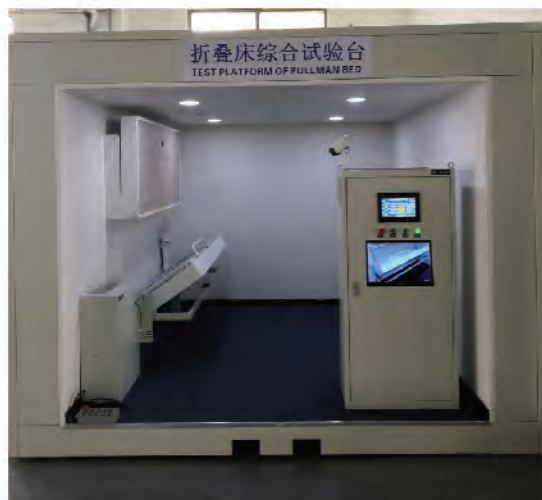

疲劳试验 | Fatigue Test

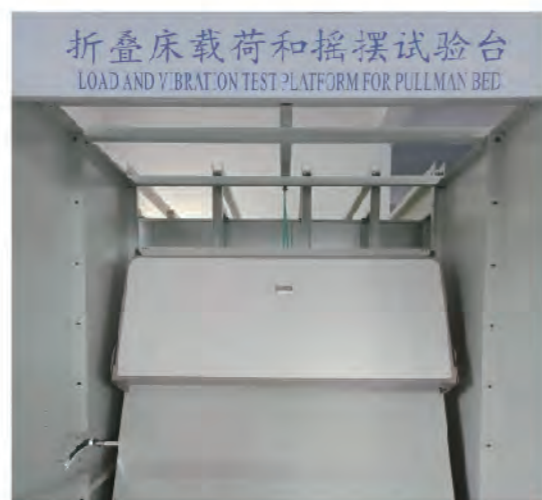

摇摆试验 | Vibration Test



静载荷试验 | Static Load Test

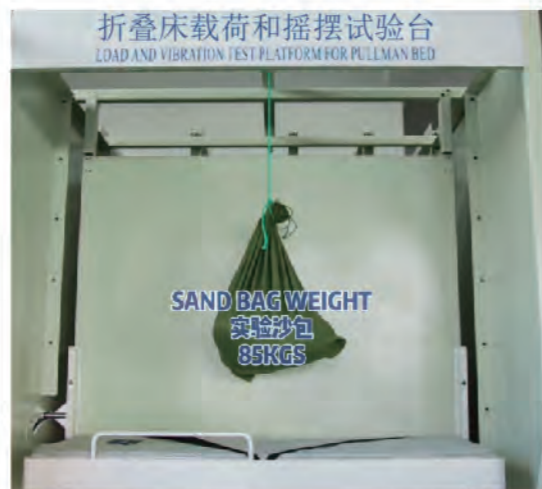

动载荷试验 | Dynamic Load Test

试验项目 TEST ITEM	测试结果 TEST RESULT
折叠床重量 PULLMAN BED WEIGHT	< 35KGS (基于2000*800MM尺寸)
疲劳试验 FATIGUE TEST	开合次数 > 40000 次, 5次/天, 使用寿命大于20年。 Opening and Closing Times > 40000times, 5 times/day, Service life more than 20 years.
摇摆实验 VIBRATION TEST	开合角度 ± 25°, 15秒/周期, 在摇摆过程中无异常开启现象。 Opening and closing Angle ± 25°, 15s/cycle. There was no abnormal opening during the vibrating process.
静载荷 STATIC LOAD	350千克, 保持30分钟, 结果无变形、损坏及异常情况发生。 350kgs, Loaded 30mins, results no deformation, damage and abnormality occurred.
动载荷 DYNAMIC LOAD	85千克, 300mm高自由落体, 结果无变形、损坏及异常情况发生。 85kgs, Free Fall at 300mm, results no deformation, damage and abnormality occurred.

钢质床 STEEL BED



钢质单层床
Steel single-berth bed
材质: 镀锌钢板
Material: Galvanized steel



钢质双层床
Steel bunk bed
材质: 镀锌钢板
Material: Galvanized steel

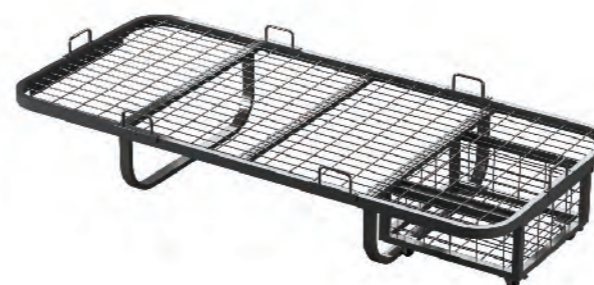

钢丝单人床
Steel wire single bed
材质: 镀锌钢
Material: Galvanized steel



钢丝双人床
Steel wire double bed
材质: 镀锌钢
Material: Galvanized steel

镜柜浴柜系列

MIRROR CABINET & BATHROOM CABINET SERIES

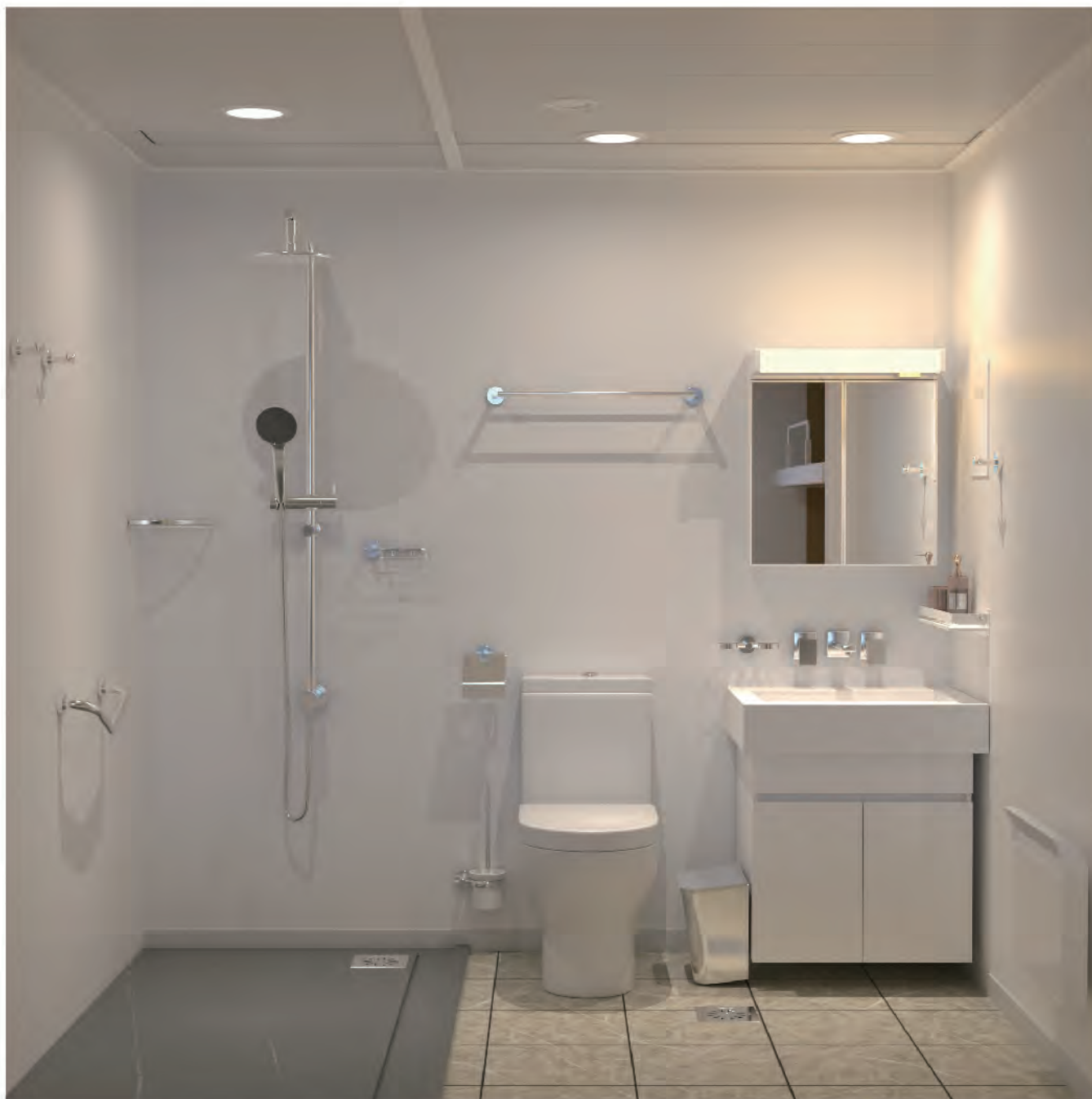

豪华邮轮镜柜: 针对豪华邮轮舒适、奢华的特点，产品在造型、配件选用、外观处理等方面凸显个性、精益求精，受到国外客户广泛认可。应用于高端船舶市场。

舰用镜柜: 针对舰船使用环境的特殊性，采用防指纹不锈钢、无焊点连接工艺制作，自带 LED 镜前灯，实用、可靠。广泛应用于军方市场。

集成全铝镜柜、浴柜: 具有重量轻、防火、防水、防腐、防虫，无甲醛、环保可回收等优点，并在产品内部集成了 LED 照明、防雾、杀菌消毒、毛巾烘干、时间显示、无线连接等系列选配功能，安全、便利、实用、智能。

化妆镜: 采用优质环保无铜镜，以更好的应用于潮湿等恶劣环境。并集成了安全低压 LED 照明、防雾等功能，画面清晰、功能实用、造型时尚、安全可靠，应用于国内多个重要商业项目。

Cruise Mirror Cabinet: Focus on style, accessories and appearance of cabinet according to the characteristics of comfort and luxury of cruise. Personalized design and first class quality make our products widely recognized by foreign clients. It applies in high end vessel market.

Naval Mirror Cabinet: considering the particularity of the using environment of naval vessels, it adopts fingerprint proof stainless steel and solder-less connection process to make. With LED lighting makes it more practical and stable. These kinds of products are widely used in military market.

Aluminum integrated mirror cabinet, bathroom cabinet: With light weight, fireproof, waterproof, anti-corrosive, insect-proof non-formaldehyde, environment-friendly and recyclable advantages. Customers can choose some optional functions, such as integrated LED lighting, defogger, sterilization, towel drying, time display. wireless connection and others. It's safe, convenient, practical and intelligent.

Cosmetic Mirror: Adopt high quality, environment-friendly, copper free mirror to better apply to moist and bad environment, It is integrated with the functions of safe low pressure LED lighting, anti-fog and other functions. Clear and bright picture quality, practical function and fashion design makes our products widely used in many project in China.

豪华邮轮镜柜
CRUISE MIRROR CABINET



CM382-LAS+CL8W
 铝合金镜柜
 Aluminum Mirror Cabinet



CM520-DAS+CL2*9W
 铝合金镜柜
 Aluminum Mirror Cabinet



CM645-DAS+CL18W
 铝合金镜柜
 Aluminum Mirror Cabinet

船用镜柜
MARINE MIRROR CABINET



JM400



JM600



DM900

舰用镜柜
NAVAL MIRROR CABINET



AM350-LSP
 不锈钢镜柜
 Stainless Steel Mirror Cabinet



AM600-DSP
 不锈钢镜柜
 Stainless Steel Mirror Cabinet



AM900-DSP&AM1200-DSP
 不锈钢镜柜
 Stainless Steel Mirror Cabinet



CM295A



FM490



BM600



CM382A/CM410A



CM382/CM486



CM648

浴室柜 BATHROOM CABINET



JM0810
JYG1200-A



AM800
JYG900



AM400
JYG600



AM1200
JYG1400



JYG750-A



JYG1500-A

化妆镜系列 BACKLIT MIRROR SERIES



JM0608



JM0711A



JM0611



JM0612

卫浴五金 BATHROOM HARDWARE



不锈钢单/双杆毛巾架
Stainless steel single/double towelbar



不锈钢浴巾架
Stainless steel towelbar



不锈钢化妆品托架
Stainless steel cosmetic shelf



不锈钢防浪扶手
Stainless steel bathroom handrail



不锈钢手纸盒
Stainless steel tissue box



不锈钢手纸架
Stainless steel tissue holder



不锈钢皂篮
Stainless steel soap holder



不锈钢地漏
Stainless steel floor drain



不锈钢单杯架
Stainless steel single tooth cup-holder



不锈钢双杯架
Stainless steel double tooth cup-holder



不锈钢衣帽钩
Stainless steel coat hook



不锈钢马桶刷
Stainless steel toilet brush



镀锌钢板/不锈钢抽风头
Galvanized steel / Stainless steel exhaust valve



不锈钢抽风头
Stainless steel exhaust valve



不锈钢废纸篓
Stainless steel trash can



水箱
Toilet water tank

电气设备 ELECTRIC EQUIPMENT



采用先进的设计理念，精湛的加工工艺，为客户定制各种电气设备。

如：电控柜、配电箱、电加热器、船用灯具、电气附件及船载岸电系统等。

Adopt advanced design concept, exquisite processing technology, for customers to customize all kinds of electrical equipment.

Such as: electric control cabinet, distribution box, electric heater, Marine lamp, Electric accessories and shipboard shore power system.

电控柜系列 ELECTRIC CONTROL CABINET SERIES



控制台
Control panel



电控柜
Electric control cabinet



电控柜
Electric control cabinet

配电箱（接线箱）系列 JUNCTION BOX SERIES



船用接线箱
Marine junction box
型号/Type:JXT12-1
材质:镀锌钢板
Material:Galvanized steel sheet
防护等级/Protection class:IP56
产品可定制/Product customizable



不锈钢接线箱
Stainless steel junction box
型号/Type:JXT12-5
材质:不锈钢
Material:Stainless steel
防护等级/Protection class:IP56
产品可定制/Product customizable



船用接线箱
Marine junction box
型号/Type: WJ1
材质:不锈钢
Material:Stainless steel
防护等级/Protection class: IP56
产品可定制/Product customizable



船用接线箱
Marine junction box
型号/Type: WJ2
材质:不锈钢
Material:Stainless steel
防护等级/Protection class: IP56
产品可定制/Product customizable

电加热器系列 ELECTRIC HEATER SERIES



电加热器
Electric Heater
材质 Material:
镀锌钢板 Galvanized Steel
型号 Type:
CDRQ 300w/400w/500w/600w/800w
参数 Parameter:
220-230v 50hz/60hz



电加热器
Electric Heater
材质 Material:
镀锌钢板 Galvanized Steel
型号 Type:
CDRQ 1000w/1200w/1500w/2000w
参数 Parameter:
220-230v 50hz/60hz

船载岸电系统 SHIPBOARD SHORE POWER SYSTEM



岸电箱
Shore connection box



测量箱
Measuring box



联调试验箱（仅用于试验）
Joint adjustment test chamber (Only for test)



电缆绞车
Cable winch

船用灯具系列 MARINE LIGHT SERIES

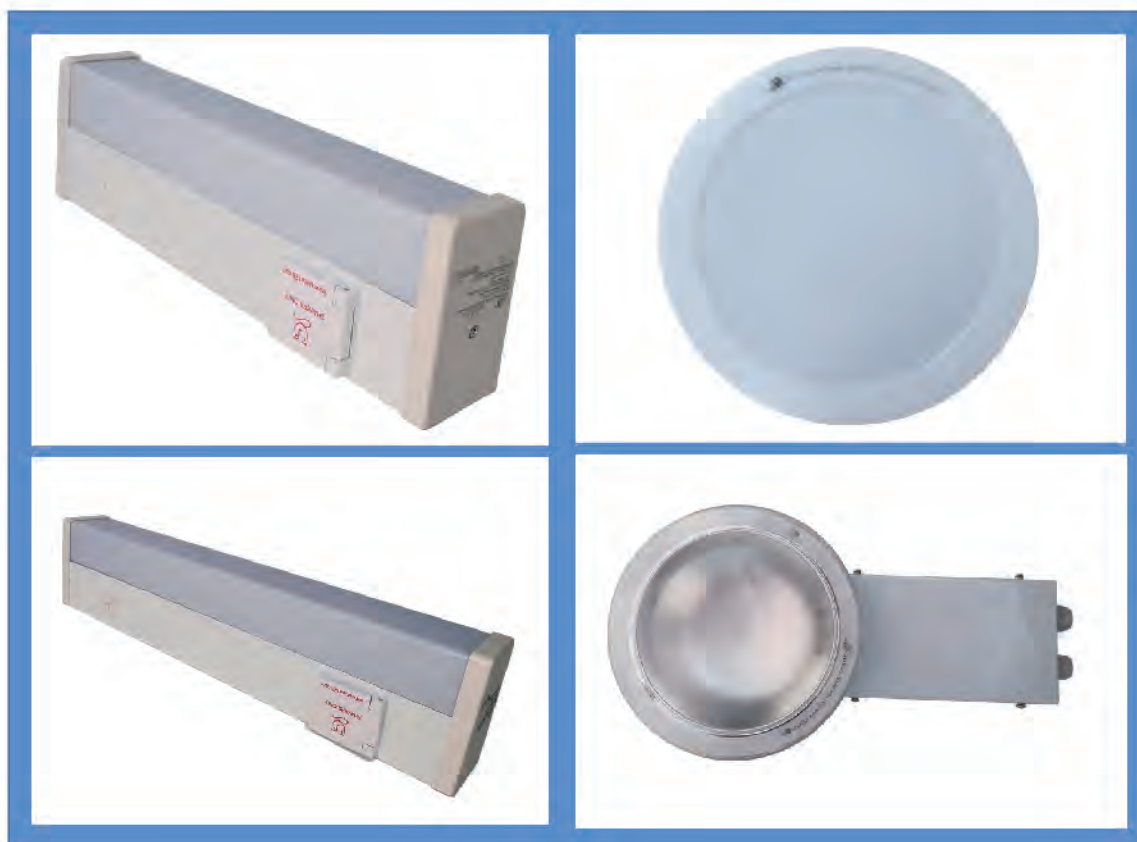

船用LED照明灯具：将LED照明技术应用于船舶照明之中，重量轻、无噪音、无干扰、节能高效。如：LED舱顶灯、蓬顶灯、D型天花板灯、镜前灯等。其中D型天花板灯与D型天花无缝结合，形成整体，美观，安装方便。

Marine LED Lamp: Apply LED lighting technology to marine light fixture, light weight, no electric noise, no interference, saving energy with efficiency, such as LED pendant light, ceiling light, D type ceiling light, mirror light and so on. Especially the D type ceiling light match with D type ceiling, totally match, no gap to be a entirety beautiful appearance and easy to install.

船用灯具 MARINE LIGHT



LED/荧光 镜前灯 LED/Fluorescent mirror light
型号/Type:CL7W****A(LED)
CL15W****A(荧光/Fluorescent)
尺寸/Size:486x113x66(mm)
防护等级/Protection class:IP44

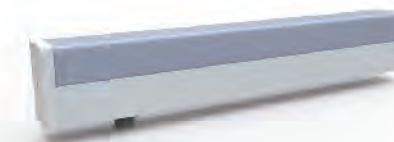

LED镜前灯 LED mirror light
型号/Type:CL18W000(18W)
尺寸/Size:648x113x63(mm)
防护等级/Protection class:IP44



LED/荧光 镜前灯 LED/Fluorescent mirror light
型号/Type:CL7W****B(LED)
CL15W****B(荧光/Fluorescent)
尺寸/Size:648x141.5x63(mm)
防护等级/Protection class:IP44



荧光镜前灯 Fluorescent mirror light
型号/Type:CB11W110B(11W)
尺寸/Size:316x116x77.5(mm)
防护等级/Protection class:IP44



荧光镜前灯 Fluorescent mirror light
型号/Type:CB14W011A(14W)
尺寸/Size:800x120x62.2(mm)
防护等级/Protection class:IP44



荧光壁灯 Fluorescent wall light
型号/Type:CL18W000C(18W)
尺寸/Size:650x113x63(mm)
防护等级/Protection class:IP44



LED/荧光 壁灯 LED/Fluorescent wall light
型号/Type:CB7W(7W-LED)
CB15W(15W-荧光/Fluorescent)
尺寸/Size:517x125x65(mm)
防护等级/Protection class:IP44

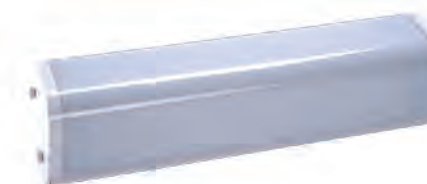

LED/荧光 走道灯 LED/Fluorescent corner light
型号/Type:JBL7-1(7W-LED)
JBY15-1(15W-荧光/Fluorescent)
尺寸/Size:673x125x125(mm)
防护等级/Protection class:IP44



LED床头灯 LED ceiling light
型号/Type:JTL04-1(4W)
尺寸/Size:332x90x43(mm)
防护等级/Protection class:IP34

船用灯具 MARINE LIGHT



LED床头灯 LED bedside light
型号/Type:JTL09-1(9W)
尺寸/Size:230x170x65(mm)
防护等级/Protection class:IP44



LED壁灯 LED wall light
型号/Type:CB9-300(9W)
尺寸/Size:300x390x86(mm)
防护等级/Protection class:IP20



荧光灯 Fluorescent downlight
型号/Type:CWTD-6C(18W/2x18W)
尺寸/Size:φ210x355x100(mm)
防护等级/Protection class:IP44



荧光灯 Fluorescent downlight
型号/Type:CWTD-5C(13W/18W/2x13W/2x18W)
尺寸/Size:φ177x393x77.5(mm)
防护等级/Protection class:IP44



LED筒灯 LED downlight
型号/Type:CWTD-6L-B(9W)
尺寸/Size:φ210(mm)
防护等级/Protection class:IP44



LED筒灯 LED downlight
型号/Type:CWTD-6L-A(9W)
尺寸/Size:φ177(mm)
防护等级/Protection class:IP44



LED筒灯 LED downlight
型号/Type:CWTD-6L-180(9W)
尺寸/Size:φ180(mm)
防护等级/Protection class:IP44
产品可定制/Product customizable



LED筒灯 LED downlight
型号/Type:CWTD-6L-180S(9W)
尺寸/Size:φ180x180x50(mm)
防护等级/Protection class:IP44
产品可定制/Product customizable



LED/荧光 蓬顶灯 LED/Fluorescent ceiling light
型号/Type:JPL11-2(2x9W-LED)
JPY21-2(2x20W-荧光/Fluorescent)
防护等级/Protection class:IP44
产品可定制/Product customizable



LED/荧光 蓬顶灯 LED/Fluorescent ceiling light
型号/Type:JPL10-2(2x9W-LED)
JPY20-2(2x20W-荧光/Fluorescent)
防护等级/Protection class:IP44
产品可定制/Product customizable



LED/荧光 蓬顶灯 LED/Fluorescent ceiling light
型号/Type:JPL11T-2(2x9W-LED)
JPY21T-2(2x20W-荧光/Fluorescent)
防护等级/Protection class:IP44
产品可定制/Product customizable



LED/荧光 舱顶灯 LED/Fluorescent pendant light
型号/Type:JCL12-2(2x9W-LED)
JCY22-2(2x20W-荧光/Fluorescent)
防护等级/Protection class:IP55



LED/荧光 舱顶灯 LED/Fluorescent pendant light
型号/Type:JCL13-2(2x9W-LED)
JCY23-2(2x20W-荧光/Fluorescent)
防护等级/Protection class:IP55



LED舱顶灯 LED pendant light
型号/Type:CCD9-5(9W)
防护等级/Protection class:IP56

电气附件系列 ELECTRICAL ACCESSORIES SERIES



铜质接线盒
Copper wiring box
型号:JXH402
电压/Voltage:250V
电流/Current:10A/20A
防护等级/Protection class:IP56



接线盒
Junction box
型号/Type:JXF4-2
电压/Voltage:250V
电流/Current:10A/20A
防护等级/Protection class:IP56



塑料接线箱
Plastic junction box
型号/Type:JXT6-02
材质/Material:ABS
防护等级/Protection class:IP56



XP-100/2EM
XP-100/2EF



XP-100/5BM
XP-100/5BF



XP-100/6MP
XP-100/6FP



XP-200/B3T



XP-100/3BM
XP-100/3BF
XP-100/L



XP-100/3T
XP-100/3M



XP-100/3T
XP-100/3H



XP-100/6B

自动打磨机
AUTOMATIC
GRINDING MACHINE



为解决折叠床框和箱柜类产品人工打磨问题，公司自主研发了五轴龙门式自动打磨机，该设备精度高，刚性强，操作简单，高效耐用，公司的大量产品成功实现了打磨自动化。

In order to solve the manual grinding problem of Pullman bed frame and cabinet products, SHIPE has independently developed a five-axis gantry automatic grinding machine. The equipment is with feature of high precision, strong rigidity, simple operation, high efficiency and durable. A large number of products of our company have successfully achieved grinding automation.

自动打磨机 AUTOMATIC GRINDING MACHINE

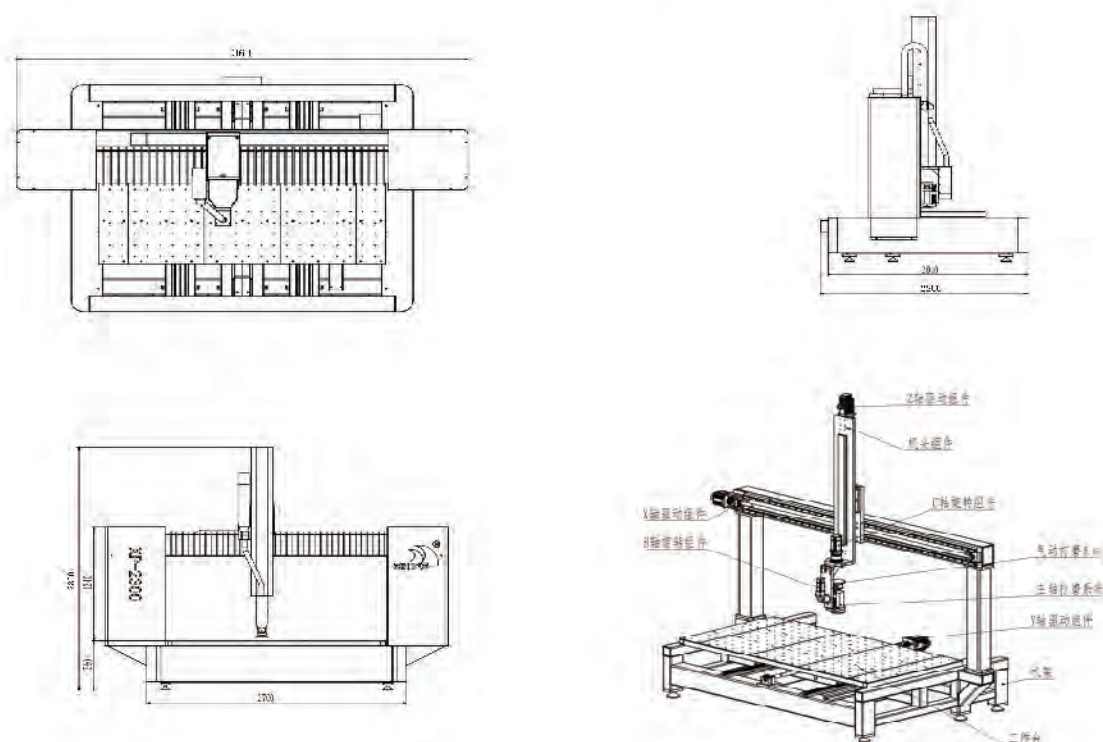

- 本设备主要运用于钣金件、铆焊件、铸造件等打磨抛光工作量大，质量要求高的产品上。
- 特别采用了龙门式结构，可对大型的工件进行打磨抛光作业。
- 打磨速度可达到10-400MM/S，施加给工件的压力最大可达到1MPA。
- 通过专门配套研发的控制软件，本机可以实现五轴联动，对工件进行打磨抛光，并可进行曲面加工。
- 气动打磨系统的设计可以实时精确控制打磨抛光力度，对来料一致性要求大幅降低，工件打磨后表面光滑。
- 具有先进的可调节实时振动打磨抛光功能，可极大提高打磨抛光效果。
- 机架采用了一体式加工，整体热处理方法，精度高刚性强。
- 本设备操作简单可靠，对操作人员无特殊要求，具有初中以上水平，进行简单培训后即可操作。
- 操作员通过手摇轮进行坐标定位，现场编程，编程结束后可进行模拟测试修正。
- 有急停、行程限位、过载保护、安全位控制、启动警示等各种安全保护措施，按照要求进行操作安全可靠。

- The equipment is mainly used for grinding and polishing sheet metal parts, riveting welding parts, casting parts and other products with large workload and high quality requirements.
- Specially adopts the gantry structure, which can grind and polish the large workpiece.
- The grinding speed can reach 10-400mm/s, and the maximum pressure applied to the workpiece can reach 1MPA.
- Through specially developed control software, the machine can realize five-axis linkage, grind and polish the workpiece, and process the curved surface.
- The design of pneumatic grinding system can control the force of grinding and polishing accurately in real time, which greatly reduces the requirement of consistency of incoming materials and makes the surface of workpiece smooth after polishing.
- Has advanced adjustable real-time vibration polishing function, which can greatly improve the polishing effect.
- The frame adopts the integral processing, the whole heat treatment method, the precision is high and the rigidity is strong.
- The equipment is simple and reliable, with no special requirements for operators. It can be operated after junior high school level or above and simple training.
- Coordinate positioning is carried out by the operator through the hand wheel, and on-site programming is carried out. After the programming, simulation test correction can be carried out.
- With emergency stop, travel limit, overload protection, safety position control, start warning and other safety protection measures, according to the requirements to operate, safe and reliable.

打磨钣金件、铆焊件、铸造件等打磨抛光工作量大，质量要求高的产品

Polishing sheet metal parts, riveted welding parts, casting parts and other polishing work with large workload, high quality requirements product

项目	单位	规格参数
XYZ 行程 (二维)	mm	2400x1200
XYZ 行程 (三维)	mm	2200x1000x800
最大定位速度	mm/s	800
重复定位精度	mm	0.1
打磨速度 (可外置)	mm/s	10-400
外部尺寸 (不含外罩)	mm	3600x2200x2800
供电电压	V	380
总功率	KW	7
输入气压	Mpa	0.6
净重	Kg	1500
最大打磨尺寸 (可定制)	mm	2200*1000*800

自动打磨机 AUTOMATIC GRINDING MACHINE

PK 人工打磨和机械 臂打磨 PK Manual & Mechanical-Arm Grinding and Polishing

1. PK人工打磨, 节省人力, 一个工作单元配置三台设备加工效率最高;
Saving manpower, processing efficiency for one unit of work with three equipment is the highest;
2. PK人工打磨, 好管理, 彻底解决“用工难”问题;
Good management, thoroughly solve the problem of "labor shortage"
3. PK人工打磨, 机器自动化作业, 打磨效果更稳定;
Automatic machine operation, more stable grinding effect;
4. PK机械臂, 可打磨的工件尺寸更大, 有效解决了机械臂远端打磨力度小的问题;
The size of the workpiece that can be polished is larger, which effectively solves the problem of small grinding force at the far end of the mechanical arm.

PK

人工打磨
Manual Grind

机械臂打磨
Mechanical-Arm Grind

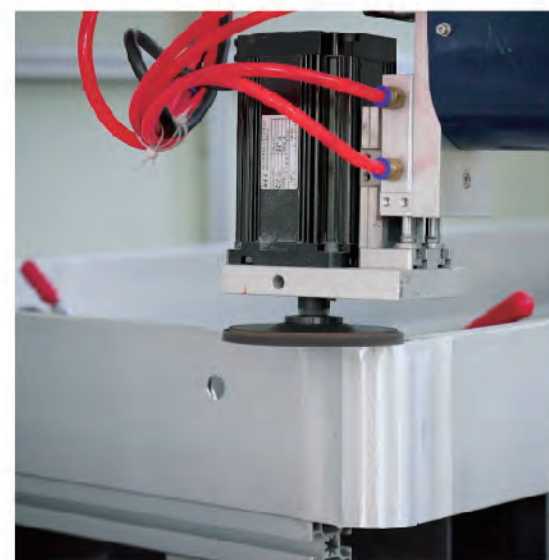
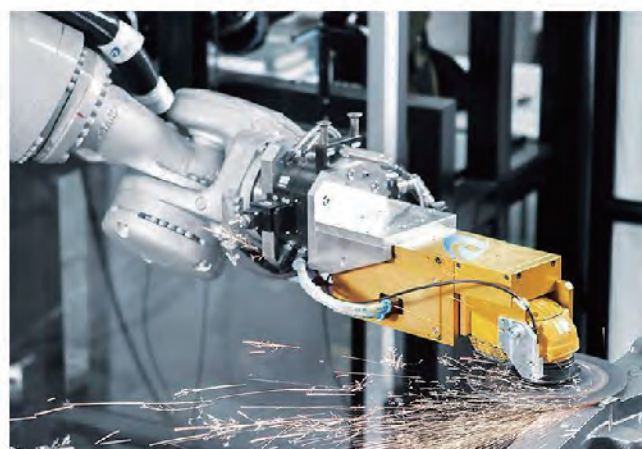

定制化产品
CUSTOMIZED PRODUCT



协普依托产业发展布局,力争为高端船舶客户提供全方位定制化产品。

Relying on the layout of industrial development, SHIPE strives to provide all-round customized products for high-end ship customers.

定制化产品
CUSTOMIZED PRODUCTS



膨胀水箱
EXPANSION TANK



消音器
SILENCER



航空加液检测车
AERIAL REFUELING INSPECTION VEHICLE



排气执行机构
EXHAUST ACTUATOR

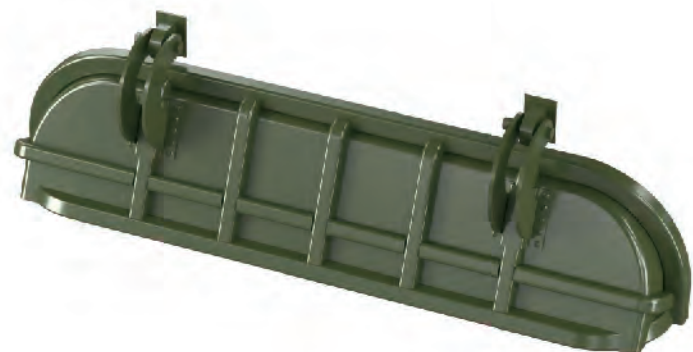

艏舌板
STERN TONGUE PLATE

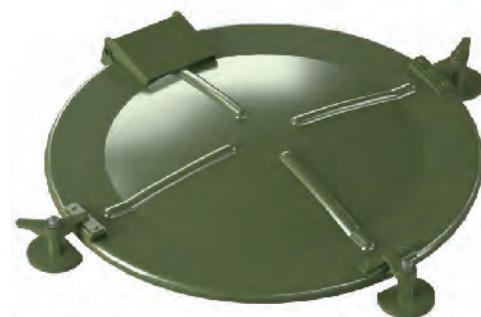

艏舱口盖板
BOW HATCH COVER



冷却器节气门总成
COOLER THROTTLE ASSEMBLY



进气挡板总成
INTAKE BAFFLE ASSEMBLY

定制化产品
CUSTOMIZED PRODUCTS

定制化产品
CUSTOMIZED PRODUCTS



排气管盖
EXHAUST PIPE COVER



油箱箱体
TANK



油箱箱体
TANK



油箱箱体
TANK